

SP1 Stereo Vision System

User Manual

(v1.8) May 26, 2016



Nerian Vision Technologies
Dr. Konstantin Schauwecker
Gotenstr. 9
70771 Leinfelden-Echterdingen
Germany

Email: service@nerian.com
<http://nerian.com>

Contents

1	Functionality Overview	3
2	Included Parts	3
3	General Specifications	3
3.1	Hardware Details	3
3.2	Stereo Matching	4
3.3	Image Rectification	4
4	Mechanical Specifications	4
4.1	Dimensions	4
4.2	Mounting	4
5	Physical Interfaces	4
6	Hardware Setup	6
6.1	Connecting the SP1	6
6.2	Supported Cameras	8
6.2.1	Cameras Recommended for 640 x 480 Resolution	8
6.2.2	Cameras Recommended for 800 x 592 Resolution	8
6.3	Camera Alignment	9
6.4	Other Image Sources	9
6.5	External Trigger	10
6.6	Time Synchronization Signal	11
7	Processing Results	11
7.1	Rectified Images	11
7.2	Disparity Maps	12
7.3	Timestamps and Sequence Numbers	14
8	Configuration	14
8.1	System Status	14
8.2	Preview	15
8.3	Processing Settings	17
8.4	Cameras	19
8.4.1	Camera Selection	19
8.4.2	Camera Settings	19
8.4.3	Recommended Settings for Point Grey Cameras	20
8.4.4	Recommended Settings for IDS Imaging Cameras	21
8.5	Trigger	21
8.6	Time Synchronization	22
8.7	Camera Calibration	22
8.7.1	Calibration Board	22

8.7.2	Recording Calibration Frames	24
8.7.3	Performing Calibration	25
8.8	Reviewing Calibration Results	26
8.9	Auto Re-calibration	28
8.10	Network Settings	29
8.11	Maintenance	30
9	API Usage Information	31
9.1	General Information	31
9.2	ImageTransfer Example	32
9.3	AsyncTransfer Example	33
9.4	3D Reconstruction	34
10	Supplied Software	34
10.1	SpCom Sample Application	34
10.2	GenICam GenTL Producer	36
10.2.1	Installation	36
10.2.2	Virtual Devices	37
10.2.3	Device IDs	37
10.2.4	Device Enumeration	38
10.3	ROS Node	38
11	Support	39
12	Warranty Information	39
13	Open Source Information	39

1 Functionality Overview

The SP1 stereo vision system is a stand-alone processing system for performing stereo matching in real time. It connects to two industrial USB cameras that provide input image data. The SP1 correlates the images of both cameras and produces a disparity map, which is transmitted through gigabit ethernet. The disparity map describes a mapping of image points from the left camera image to corresponding image points in the right camera image. With this information it is possible to reconstruct the 3D location of the corresponding scene points.

2 Included Parts

When ordering a new SP1 from Nerian Vision Technologies, the package should include the following items:

- SP1 stereo vision system
- 5 V DC power adapter
- 4 stickable rubber pads
- Mounting plate
- 4 mounting screws
- Manual

If any of the listed items is missing in your delivery, then please contact us.

3 General Specifications

3.1 Hardware Details

Power consumption	< 4 W
Power supply	5 V DC
Dimensions	105 x 76 x 36 mm
Weight	0.25 kg
I/O	USB 2.0 host, Gigabit Ethernet, 2x trigger out, synchronization input (pin shared with trigger 1)
Max. USB power	500 mA

3.2 Stereo Matching

Stereo algorithm	Semi-Global Matching (SGM)
Disparity range	112 pixels
Sub-pixel resolution	4 bits (1/16 pixel)
Supported frame rates	30 fps for resolution 640×480 pixels 20 fps for resolution 800×592 pixels
Supported image sizes	Configurable from 320×240 pixels up to 800×800 pixels
Post-processing	Consistency check, uniqueness check, gap interpolation, noise reduction, speckle filtering

3.3 Image Rectification

Horizontal displacement	-39 to +39 pixels
Vertical displacement	-39 to +39 pixels
Interpolation	Bilinear

4 Mechanical Specifications

4.1 Dimensions

Figures 1a to 1d show the SP1 as seen from front, rear, side and top. The provided dimensions are measured in millimeters.

4.2 Mounting

For mounting the SP1 please use the included mounting plate. The mounting plate is attached to the bottom of the SP1 with the four included mounting screws. The four through holes at the corners of the plate allow the SP1 to be fixed onto a flat surface. The through holes are compatible to screws with an M4 ISO metric thread.

An image of the SP1 with attached mounting plate is shown in Figure 2. The dimensions of the mounting plate are shown in millimeters in Figure 3. Please only use the provided screws for attaching the plate or any other object to the SP1. **Using screws with a higher length might damage the inside electronics.**

5 Physical Interfaces

Figures 4a and 4b show the interfaces on the SP1's front and backside. The power jack is located on the backside, and it needs to be connected to the supplied power adapter or an equivalent model. When using an alternative

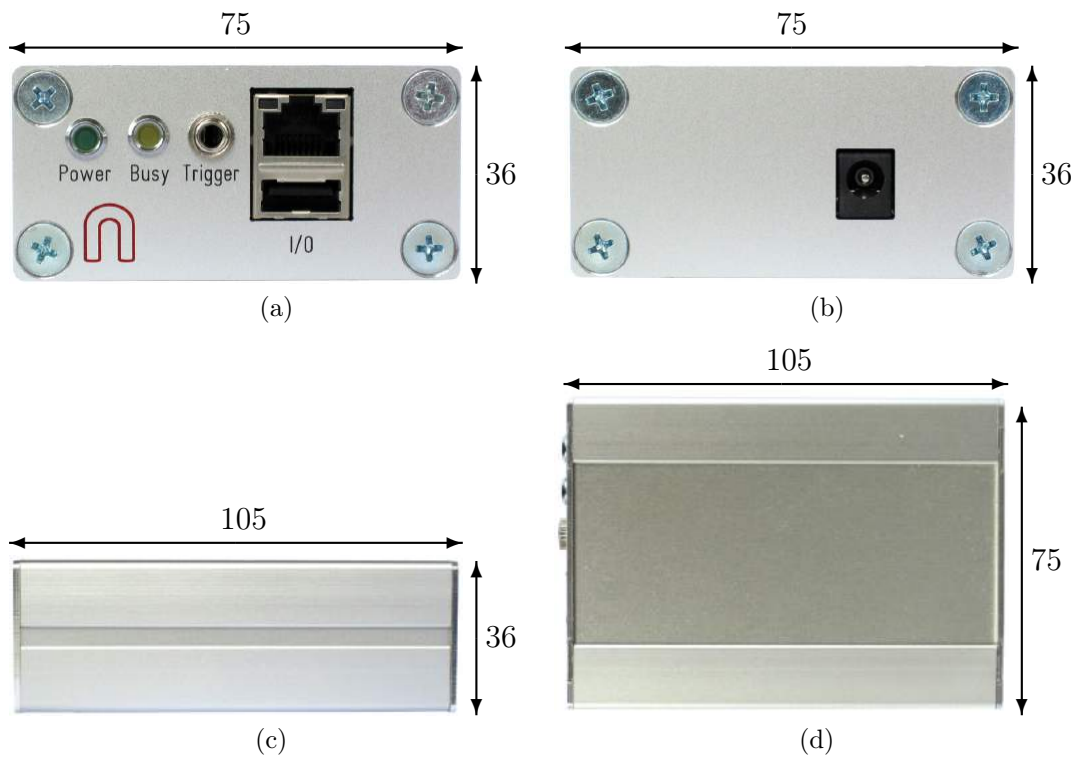

Figure 1: (a) Front, (b) rear, (c) side and (d) top view of SP1 with dimensions in millimeters.



Figure 2: SP1 with attached mounting plate.

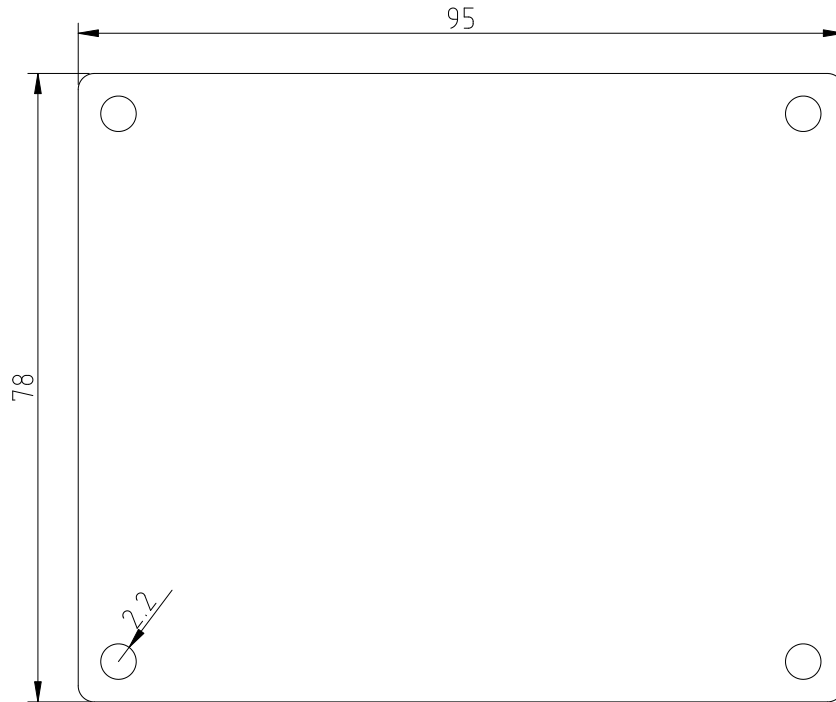

Figure 3: Mounting plate dimensions in millimeters.

power supply, please make sure that the voltage is set to 5 V DC. Higher voltages might damage the device.

The front side features the following interfaces:

Power LED: Indicates that the device is powered up and running.

Busy LED: Indicates that the device is currently processing image data.

Trigger port: Port for providing two camera trigger signals. It is possible to disable one trigger signal and use the dedicated pin as input for a synchronization signal. Please see Sections 6.5 and 6.6.

Ethernet port: Port for connecting to a client computer. It is used for delivering processing results and for providing access to the configuration interface.

USB port: Port for connecting the desired USB cameras through a USB hub.

6 Hardware Setup

6.1 Connecting the SP1

Figure 5 shows a basic system setup for stereo vision. A client computer that receives the processing results is connected to the SP1's ethernet port.

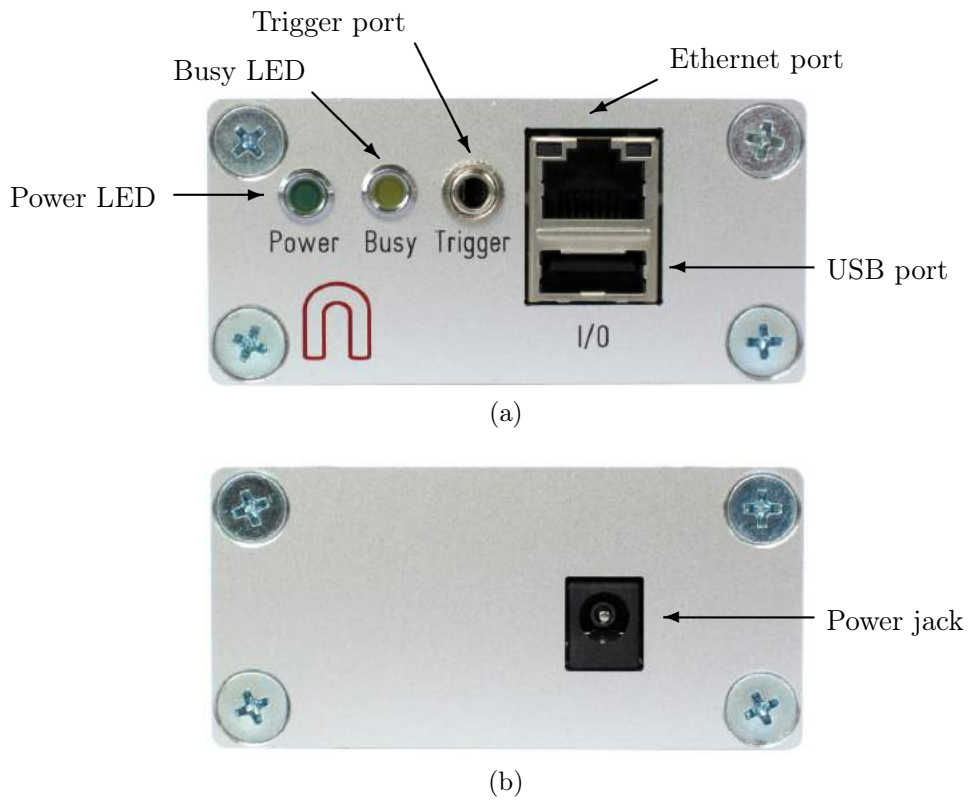

Figure 4: Interfaces on (a) front and (b) rear housing side.

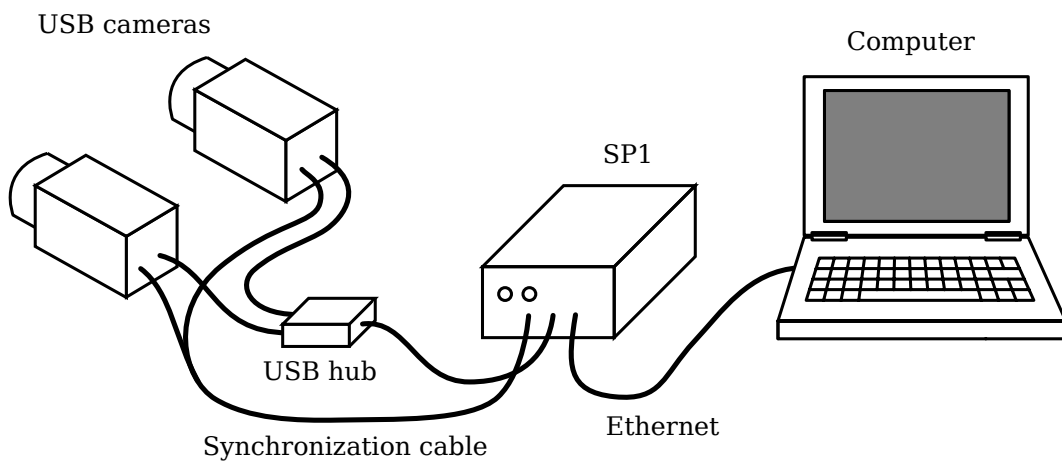

Figure 5: Example setup for cameras, SP1 and client computer.

Alternatively it is possible to connect the SP1 to a switched network. However, you have to ensure that the network is capable of handling the high bandwidth data that is transmitted by the device. The network must support data rates of at least 25 MB/s.

The cameras are connected to the SP1's USB port. As the SP1 only features one USB port, a USB hub is mandatory for making this connection. **Please note that the USB hub usually has to be powered externally, in order to meet the power consumption of the cameras.**

The image acquisition of both cameras has to be synchronized. The SP1 will only process frames with a matching time stamp. **Operating the cameras in free-run mode will thus result in dropped frames.** Depending on your configuration, synchronization might require connecting the cameras to the SP1's trigger port (see Section 6.5).

6.2 Supported Cameras

The SP1 supports a variety of greyscale cameras from Point Grey Research Inc. and IDS Imaging Development Systems GmbH. Below you find a list of all camera models that are known to be compatible, sorted by the recommended resolution.

6.2.1 Cameras Recommended for 640 x 480 Resolution

- Point Grey Blackfly:
BFLY-U3-03S2M-CS, BFLY-U3-13S2M-CS
- Point Grey Chameleon3:
CM3-U3-13S2M-CS (**our choice**), CM3-U3-13Y3M-CS
- Point Grey Flea3:
FL3-U3-13E4M-C, FL3-U3-13Y3M-C
- Point Grey Grasshopper3:
GS3-U3-14S5M-C, GS3-U3-15S5M-C
- IDS uEye ML:
UI-3240ML-M-GL
- IDS uEye CP:
UI-3240CP-M-GL Rev.2

6.2.2 Cameras Recommended for 800 x 592 Resolution

- Point Grey Blackfly:
BFLY-U3-23S6M-C (**our choice**)



Figure 6: Example for standard epipolar geometry.

- Point Grey Flea3:
FL3-U3-20E4M-C
- Point Grey Grasshopper3:
GS3-U3-23S6M-C
- IDS uEye ML:
UI-3250ML-M-GL
- IDS uEye CP:
UI-3250CP-M-GL Rev.2

Other models of the given camera lines might also be compatible. Please contact us if you require assistance with camera selection.

6.3 Camera Alignment

Both cameras have to be mounted on a plane with a displacement that is perpendicular to the cameras' optical axes. Furthermore, both cameras must be equipped with lenses that have an identical focal length. This arrangement is known as the *standard epipolar geometry*. An example for such a camera mounting is shown in Figure 6.

The distance between both cameras is referred to as *baseline distance*. Using a large baseline distance improves the depth resolution at high distances. A small baseline distances, on the other hand, allows for the observation of close objects. The baseline distance should be adjusted in conjunction with the lenses' focal length. An online tool for computing desirable combinations of baseline distance and focal length can be found on the Nerian Vision Technologies website¹.

6.4 Other Image Sources

The SP1 can alternatively process image data that does not originate from real cameras. To allow for an easy evaluation, each SP1 ships with an example stereo sequence on its internal memory. This example sequence appears as

¹<http://nerian.com/support/resources/calculator/>

two *virtual cameras* that can be selected during camera configuration (see Section 8.4). If selected, the example sequence is replayed in an infinite loop. Due to speed limitations of the internal memory, the example sequence is not replayed at the full frame rate during the first loop iteration.

Another set of virtual cameras provide the ability to receive image data over the ethernet port. In this case, a computer transmits a set of image pairs to the SP1 and then receives the processing results over the same network. Please note that this significantly increases the required network bandwidth. The bandwidth usage can be reduced by transferring image data at a lower frame rate. It is recommended to always use TCP as underlying network protocol when performing network image transfer, in order to avoid dropped frames.

The SpCom sample application described in Section 10.1 can be used for transferring a set of locally stored images to the SP1. An example command line for using SpCom for image transfer is as follows:

```
> spcom -t -f30 -h 192.168.10.10 -s input-dir
```

In this case, a TCP connection to the SP1 with IP address 192.168.10.10 is established and image data is streamed with a rate of 30 frames per second. The image data is read from the directory `input-dir` in alphabetical order. Please make sure that images from the left camera always appear before the corresponding image from the right camera when sorted alphabetically.

6.5 External Trigger

For stereo matching it is important that both cameras are synchronized, meaning that both cameras record an image at exactly the same point of time. Many industrial cameras already feature the ability to synchronize themselves, by having one camera produce a trigger signal for the respective other camera.

As an alternative, the SP1 can produce up to two trigger signals. The signals are provided through the trigger port, which can receive a standard 3.5 mm phone connector. The pin assignment for this connector is shown in Figure 7.

The peak voltage of both trigger signals is at +3.3 V. The polarity of the trigger signals is active high. For exact timing measurements it is recommended that the cameras trigger on the rising signal edge. The pulse width and frequency can be adjusted in the trigger configuration (see Section 8.5). To protect the trigger port from short circuits, each signal line is connected through a 220 Ω series resistor.

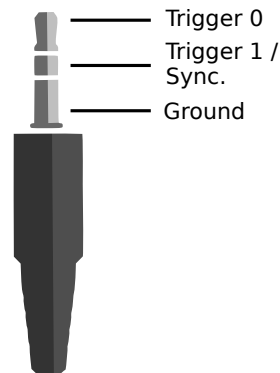

Figure 7: Pin assignement for trigger output.

6.6 Time Synchronization Signal

As indicated in Figure 7, the pin dedicated to trigger signal 1 can alternatively be configured as input for a time synchronization signal (see Section 8.6). In this case, the internal clock is set to 0 whenever a rising signal edge is received. The signal must have a voltage level of +3.3 V. Please avoid higher voltages as they might damage the device.

Clock synchronization is useful when interpreting the timestamps that are embedded in the transmitted processing results (see Section 7.3). The synchronization input can be connected to the pulse-per-second (PPS) output of a GPS receiver or a precision oscillator, in which case the clock is reset once per second. This allows for the reconstruction of high-precision timestamps on the computer receiving the SP1's processing results.

As an alternative to synchronizing to an external signal, the SP1 can also perform a clock synchronization through the Network Time Protocol (NTP), as described in Section 8.6.

7 Processing Results

7.1 Rectified Images

Even when carefully aligning both cameras, you are unlikely to receive images that match the expected result form an ideal standard epipolar geometry. The images are affected by various distortions that result from errors in the cameras' optics and mounting. Therefore, the first processing step that is performed is an image undistortion operation, which is known as *image rectification*.

Image rectification requires precise knowledge of the cameras' projective parameters. These can be determined through camera calibration. Please refer to Section 8.7 for a detailed explanation of the camera calibration procedure.

Figure 8a shows an example camera image, where the camera was pointed towards a calibration board. The edges of the board appear slightly bent, due

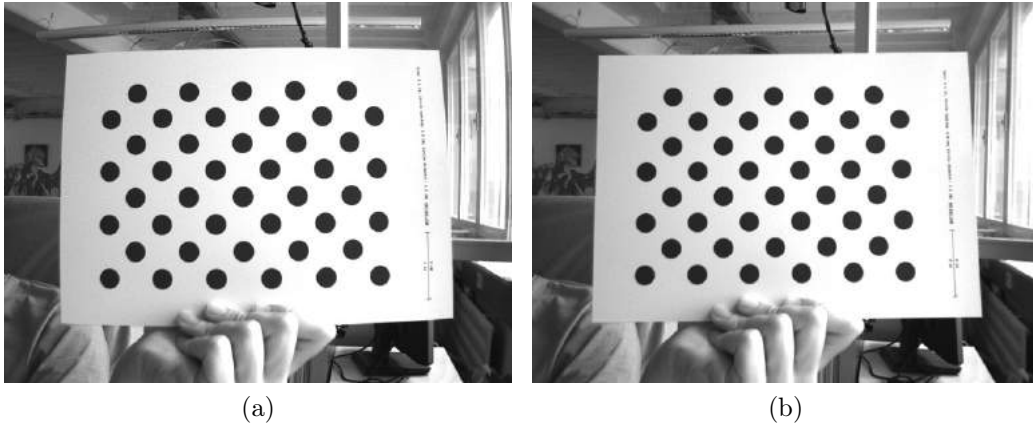

Figure 8: Example for (a) unrectified and (b) rectified camera image.

to radial distortions caused by the camera’s optics. Figure 8b shows the same image after image rectification. This time, all edges of the calibration board are perfectly straight.

When performing stereo matching, the SP1 additionally outputs the rectified left camera image. This allows for a mapping of features in the visible image to structures in the determined scene depth and vice versa.

7.2 Disparity Maps

The stereo matching results are delivered in the form of a *disparity map* from the perspective of the left camera. The disparity map assigns each pixel in the left camera image to a corresponding pixel in the right camera image. Because both images were previously rectified to match an ideal standard epipolar geometry, corresponding pixels should only differ in their horizontal coordinates. The disparity map thus only encodes a *horizontal coordinate difference*.

An example for a left camera image and the corresponding disparity map are shown in Figures 9a and 9b. Here the disparity map has been color coded, with blue hues reflecting small disparities, and red hues reflecting large disparities. The disparity is proportional to the inverse depth of the corresponding scene point. It is thus possible to transform the disparity map into a set of 3D points. This can be done at a correct metric scale if the cameras have been calibrated properly.

The transformation of a disparity map to a set of 3D points requires knowledge of the disparity-to-depth mapping matrix Q , which is computed during camera calibration and transmitted by the SP1 along with each disparity map. The 3D location $(x \ y \ z)^T$ of a point with image coordinates (u, v) and disparity d can be reconstructed as follows:

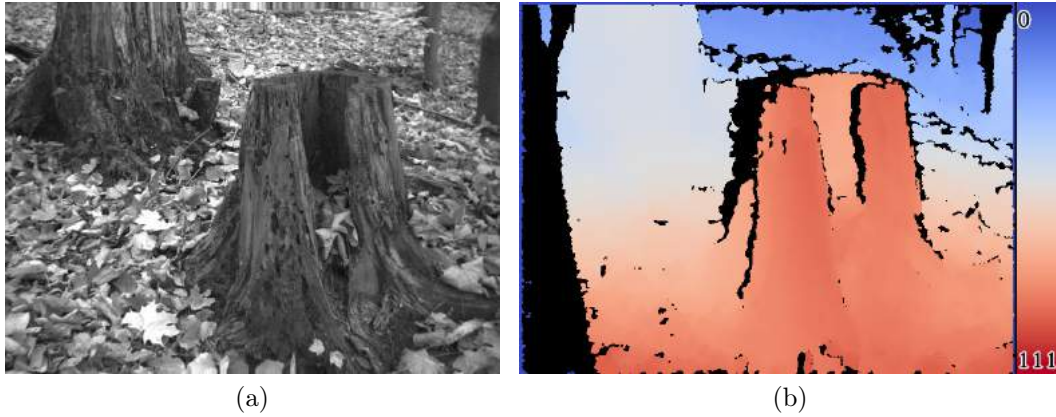

Figure 9: Example for (a) left camera image and corresponding disparity map.

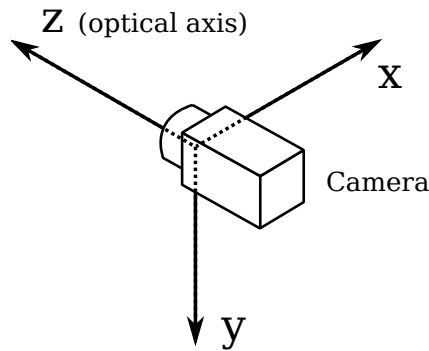

Figure 10: Coordinate system used for 3D reconstruction.

$$\begin{pmatrix} x \\ y \\ z \end{pmatrix} = \frac{1}{w} \cdot \begin{pmatrix} x' \\ y' \\ z' \end{pmatrix}, \text{ with } \begin{pmatrix} x' \\ y' \\ z' \\ w \end{pmatrix} = Q \cdot \begin{pmatrix} u \\ v \\ d \\ 1 \end{pmatrix}$$

When using the provided Q matrix, the received coordinates will be measured in meters with respect to the coordinate system depicted in Figure 10. Here, the origin matches the left camera's center of projection. An efficient implementation of this transformation is provided with the available API (see Section 9.4).

The SP1 computes disparity maps with a disparity resolution that is below one pixel. Disparity maps have a bit-depth of 12 bits, with the lower 4 bits of each value representing the fractional disparity component. It is thus necessary to divide each value in the disparity map by 16 in order to receive the correct disparity magnitude.

The SP1 applies several post-processing techniques in order to improve the quality of the disparity maps. Some of these methods detect erroneous disparities and mark them as invalid. Invalid disparities are set to 0xFF, 0xFF, 0xFF, 0xFF.

which is the highest value that can be stored in a 12-bit disparity map. In Figure 9b invalid disparities have been depicted as black.

7.3 Timestamps and Sequence Numbers

Each pair of rectified left camera image and disparity map, which is transmitted by the SP1, also includes a timestamp and a sequence number. The timestamp is measured with microsecond accuracy and is set to either the time at which a camera trigger signal was generated or the time at which a frame was received from the cameras (see Section 8.5). For images that are received over the network, as described in Section 6.4, the timestamp and the sequence number are both copied.

As explained in Sections 6.6 and 8.6, it is possible to synchronize the SP1's internal clock to an external signal or a time server. This directly affects the produced time stamps. When synchronized to a time server, time stamps are measured in microseconds since 1 January 1970, 00:00:00 UTC. If no synchronization is performed, the internal clock is set to 0 at the time the SP1 is powered up. If synchronizing to an external signal, the clock is set to 0 at the rising edge of the synchronization signal.

Please note that synchronizing to a PPS signal, as explained in Section 6.6, also produces negative timestamps. Depending on the selected timestamp source, this happens when a synchronization signal is received while the SP1 is processing an already captured image pair, or while the SP1 is waiting for a frame corresponding to an already generated trigger signal. The negative timestamp is then the time difference between the reception of the synchronization signal and the time of capturing or triggering the current image pair.

8 Configuration

The SP1 is configured through a web interface, which can be reached by entering the IP address of the SP1 in your browser. The default address is <http://192.168.10.10>. Please configure the IP address and subnet mask of your computer appropriately, such that this interface can be reached. If the SP1 has just been plugged in, it will take several seconds before the web interface is accessible.

For using the web interface you require a browser with support for HTML 5. Please use a recent version of one of the major browsers, such as Internet Explorer, Firefox, Chrome or Safari.

8.1 System Status

The first page that you see when opening the web interface is the *system status* page that is shown in Figure 11. On this page you can find the following information:

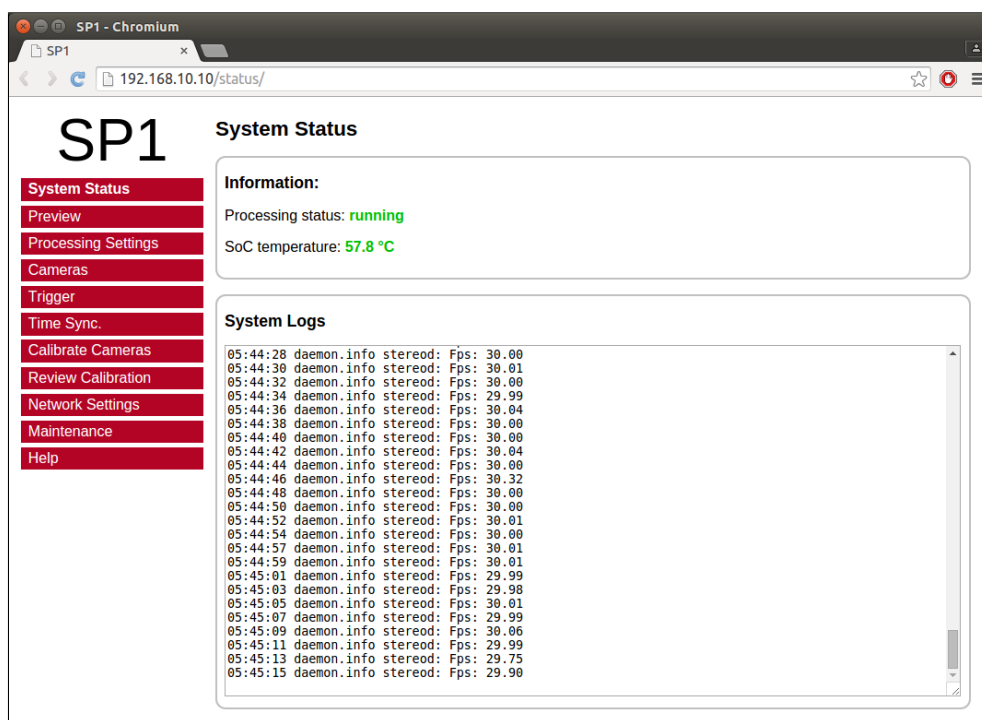

Figure 11: Screenshot of configuration status page.

Processing status: Indicates whether the image processing sub-system has been started. If this is not the case then there might be a problem accessing the cameras, or another system error might have occurred. Please consult the system logs in this case. The image processing sub-system will be started immediately once the cause of error has been removed (such as connecting the cameras).

SOC temperature: The temperature of the central System-on-Chip (SoC) that performs all processing tasks. The maximum allowed temperature is at 70 °C. A green-orange-red color-coding is applied to signal good, alarming and critical temperatures.

System logs: List of system log messages sorted by time. In regular operation you will find information on the current system performance. In case of errors, the system logs contain corresponding error messages.

8.2 Preview

The *preview* page, which is shown in Figure 12, provides a live preview of the currently computed disparity map. Please make sure that your network connection supports the high bandwidth that is required for streaming video data (see Section 6.1). For using the preview page you require a direct connection to the SP1. An in-between proxy server or a router that performs network address translation (NAT) cannot be used.

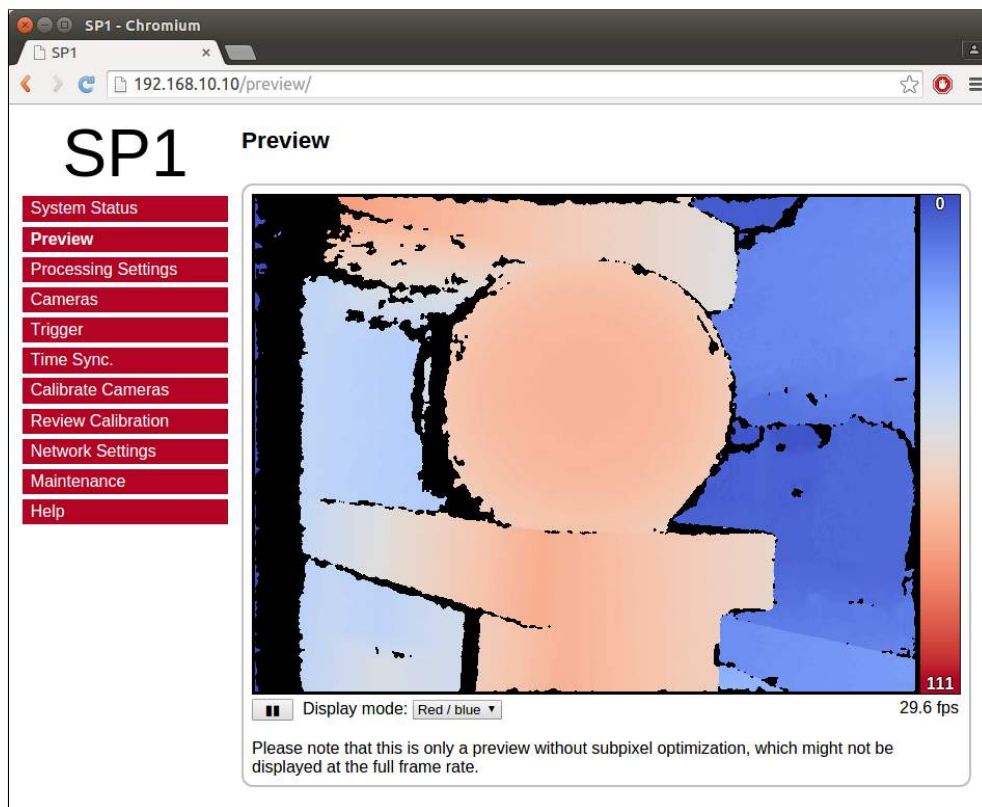

Figure 12: Screenshot of configuration preview page.

When opening the preview page, the SP1 stops transferring image data to any other host. The transfer is continued as soon as the browser window is closed, the user presses the pause button below the preview area, or if the user navigates to a different page. Only one open instance of the preview page, or any other page that is streaming video data to the browser, is allowed at a time. If attempted to open more than once, only one instance will receive data.

The preview that is displayed in the browser does not reflect the full quality of the computed disparity map. In particular, sub-pixel accuracy is not available, and your browser might not be able to display the disparity map at the full camera frame rate. To receive a full-quality preview, please use the SpCom sample application, which is described in Section 10.1.

Different color-coding schemes can be selected through the drop-down list below the preview area. A color scale is shown to the right, which provides information on the mapping between colors and disparity values. The possible color schemes are:

Red / blue: A gradient from red to blue, with red hues corresponding to high disparities and blue hues corresponding to low disparities. Invalid disparities are depicted in black.

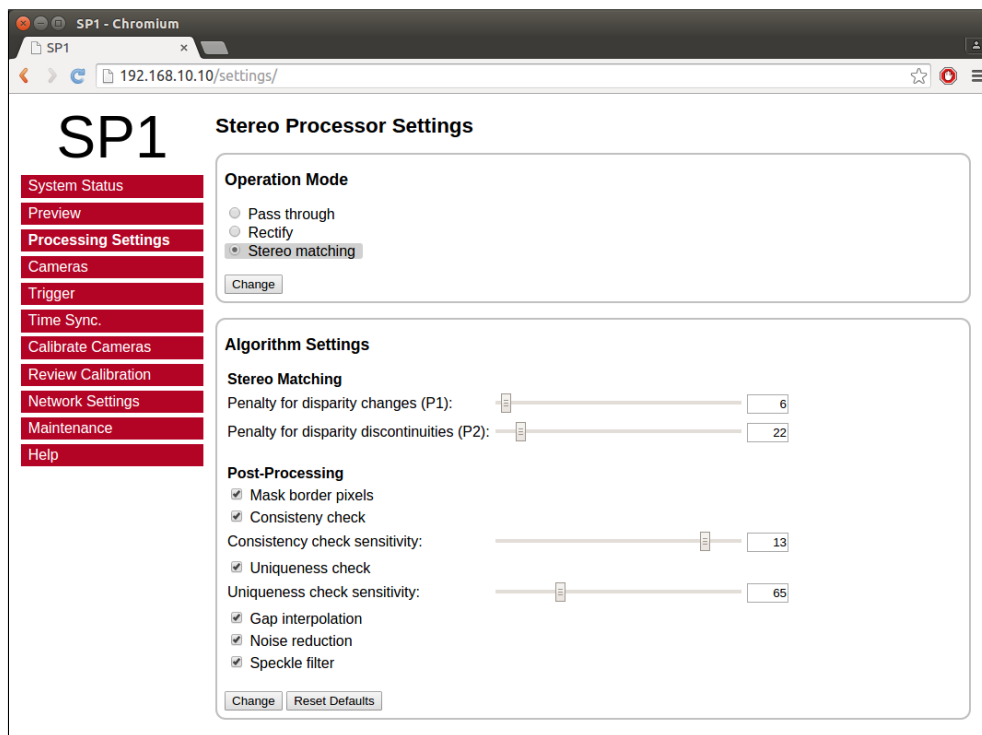

Figure 13: Screenshot of configuration page for processing settings.

Rainbow: A rainbow color scheme with low wavelengths corresponding to high disparities and high wavelengths corresponding to low disparities. Invalid disparities are depicted in grey.

Raw data: The raw disparity data without color-coding. The pixel intensity matches the integer component of the measured disparity. Invalid disparities are displayed in light gray.

8.3 Processing Settings

The major processing parameters can be changed on the *processing settings* page, which is shown in Figure 13. The most relevant option is the operation mode, which can be set to one of the following values:

Pass through: In this mode the SP1 forwards the imagery of the selected cameras without modification. This mode is intended for verifying that both cameras are functioning correctly.

Rectify: In this mode the SP1 transmits the rectified images of both cameras. This mode is intended for verifying the correctness of image rectification.

Stereo matching: In this mode the SP1 performs stereo matching. It transmits the rectified image of the left camera and the left camera disparity map.

If the operation mode is set to stereo matching, then the behavior of the image processing algorithms can be controlled through the *algorithm settings*. These settings include the following stereo matching parameters:

Penalty for disparity changes (P1): A penalty that is applied to gradually changing disparities. A large value causes gradual disparity changes to occur less frequently, while a small value causes gradual changes to occur more frequently. This value has to be smaller than P2.

Penalty for disparity discontinuities (P2): A penalty that is applied to abruptly changing disparities. A large value causes disparity discontinuities to occur less frequently, while a small value causes discontinuities to occur more frequently. This value has to be greater than P1.

The SP1 implements several methods for post-processing the computed disparity map. Each post-processing method can be activated or deactivated individually. The available methods are:

Mask border pixels: If enabled, this option marks all disparities that are close to the border of the visible image area as invalid, as they have a high uncertainty. This also includes all pixels for which no actual image data is available due to the image rectification (see Section 7.1).

Consistency check: If enabled, stereo matching is performed in both matching directions, left-to-right and right-to-left. Pixels for which the disparity is not consistent are marked as invalid. The sensitivity of the consistency check can be controlled through the *consistency check sensitivity* slider.

Uniqueness check: If enabled, pixels in the disparity map are marked as invalid if there is no sufficiently unique solution (i.e. the cost function does not have a global minimum that is significantly lower than all other local minima). The sensitivity of the uniqueness check can be controlled through the *uniqueness check sensitivity* slider.

Texture filter: If enabled, pixels that belong to image regions with little texture are marked as invalid in the disparity map, as there is a high likelihood that these pixels have been mismatched. The sensitivity of this filter can be adjusted through the *texture filter sensitivity* slider.

Gap interpolation: If enabled, small patches of invalid disparities, which are caused by one of the preceding filters, are filled through interpolation.

Noise reduction: If enabled, an image filter is applied to the disparity map, which reduces noise and removes outliers.

Speckle filter: Marks small isolated patches of similar disparity as invalid. Such *speckles* are often the result of erroneous matches.

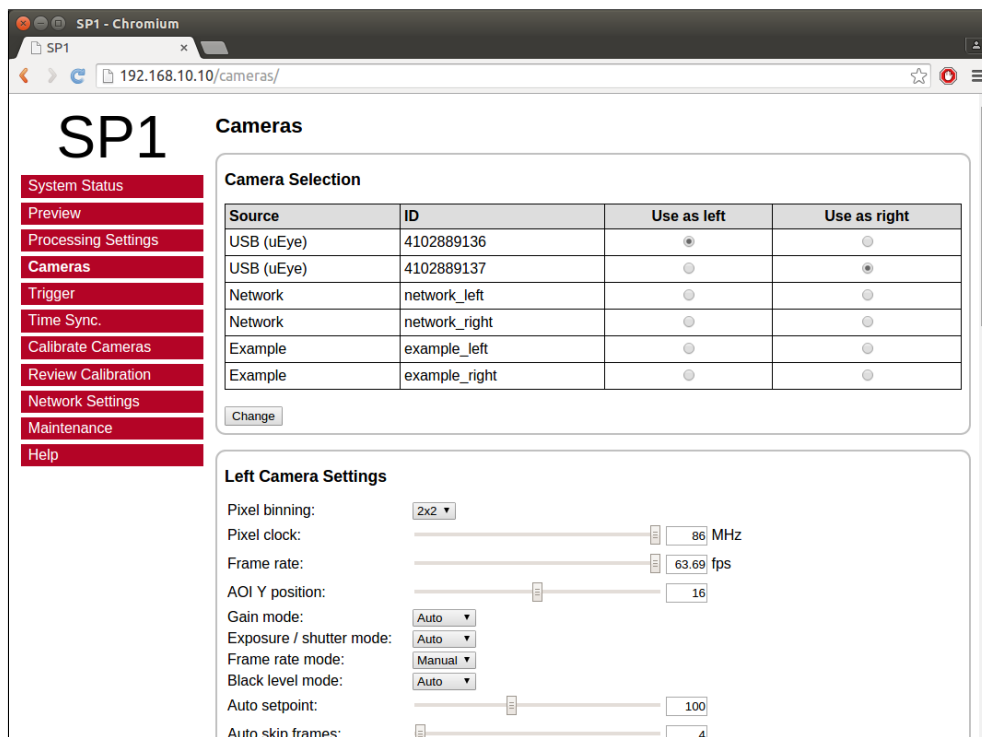

Figure 14: Screenshot of configuration page for camera settings.

8.4 Cameras

8.4.1 Camera Selection

The *cameras* page that is shown in Figure 14 allows for the selection of a desired camera pair and the adjustment of their respective parameters. All detected cameras are listed in the *camera selection* list. A source is listed for each camera, which identifies the utilized camera driver. The cameras list also includes the two virtual camera pairs that are mentioned in Section 6.4, which provide an example stereo sequence or facilitate the reception of input images through ethernet.

To choose a particular camera, you have to tick either the *use as left* or *use as right* radio button, for selecting the camera as the left or right camera of the stereo pair. Please note that cameras of different sources cannot be used together.

8.4.2 Camera Settings

After selecting a camera pair, camera specific settings can be adjusted in the *left camera settings* and *right camera settings* area. The available settings depend on your camera model. Please refer to your camera documentation for details. Some of the more advanced settings of your camera might not be available. In this case please use the software provided by the camera manu-

facturer to adjust the desired settings and save the new camera configuration to the cameras' internal memory.

By pressing the *reset camera defaults* button you can reset the camera's settings to the default configuration. This is usually the configuration that has been written to the camera's internal memory through the manufacturer software. If the *reset* button is pressed, all configuration changes that have not been confirmed through the *change* button are reverted.

For all cameras it is possible to configure the size of the processed Region Of Interest (ROI). The smaller the ROI the higher is the frame rate that can be achieved. Recommended ROI and frame rate settings are listed in Section 3.2 on page 4. When choosing a custom image size, please adjust the frame rate such that a stable processing rate is achieved.

The SP1 offers the functionality to synchronize parameters that are otherwise automatically adjusted by each camera. For example, each camera might control its shutter time through an auto shutter algorithm. The SP1 can synchronize such auto-adjusted parameters by setting the parameters of the right camera to always match the respective parameters of the left camera.

If this functionality is desired, the *mode* for the particular feature has to be set to *synchronize to left camera* in the right camera settings, and to *auto* in the left camera settings. In this case, the SP1 will query the settings of the left camera and adjust the right camera's settings accordingly.

8.4.3 Recommended Settings for Point Grey Cameras

When using Point Grey USB cameras, we recommend that you use the following settings:

- Enable external trigger and select the desired trigger source.
- If the cameras are connected to the SP1's trigger port, set the trigger polarity to *active high*. Otherwise set the polarity according to your trigger source.
- Set the trigger mode to 14 (recommended) or 0. Always use mode 14 if the internal camera frame rate is not significantly higher than the trigger frequency.
- If an automatic adjustment of exposure, sharpness and shutter is desired, then please apply the following settings:
 - For the left camera, set the mode of exposure, sharpness, shutter and gain to *auto*.
 - For the right camera, set the mode of exposure, sharpness, shutter and gain to *synchronize to left camera*.

8.4.4 Recommended Settings for IDS Imaging Cameras

When using cameras from IDS Imaging, we recommend that you use the following settings:

- If the cameras shall be triggered by the SP1 trigger output:
 - Due to voltage levels, the SP1 trigger output needs to be connected to a camera GPIO pin, rather than the trigger input.
 - The connected GPIO pin needs to be selected as trigger source.
 - The trigger mode shall be set to *hardware trigger, rising edge*.
- Set the pixel clock to maximum.
- Set the camera frame rate to at least twice the trigger frequency (the allowed framerate range is influenced by the configured pixel clock).
- If an automatic adjustment of gain, exposure / shutter and black level is desired, then please apply the following settings:
 - For the left camera, set the mode of gain, exposure / shutter and black level to *auto*.
 - For the right camera, set the mode of gain, exposure / shutter and black level to *synchronize to left camera*.
 - Leave auto skip frames at 4 (the default) in order to minimize dropped frames during adjustments.

8.5 Trigger

The *trigger* page that is shown in Figure 15 allows for a configuration of the external trigger settings. As described in Section 6.5, the SP1 features a trigger port that provides access to up to two trigger signals. The two trigger signals, *trigger 0* and *trigger 1*, can be enabled or disabled by selecting the respective check boxes.

For *trigger 0* it is possible to select a frequency between 6 and 50 Hz and an arbitrary pulse width in milliseconds. The polarity of the generated trigger signal is active high. If the checkbox ‘*use trigger time as timestamp*’ is selected, then the trigger time is transmitted as timestamp with each processing result. Please make sure that the cameras do not skip any trigger signals, as in this case the timestamp correlation will fail. This functionality should not be used with virtual cameras such as the hard-coded example and network capturing.

The signal *trigger 1* can only be enabled if *trigger 0* is also enabled. The frequency is forced to the same value as *trigger 0*. However, it is possible to specify a time offset, which is the delay from a rising edge of *trigger 0* to a rising edge of *trigger 1*. Furthermore, *trigger 1* can have a pulse width that differs from *trigger 0*. If PPS synchronization is enabled, *trigger 1* cannot be used.

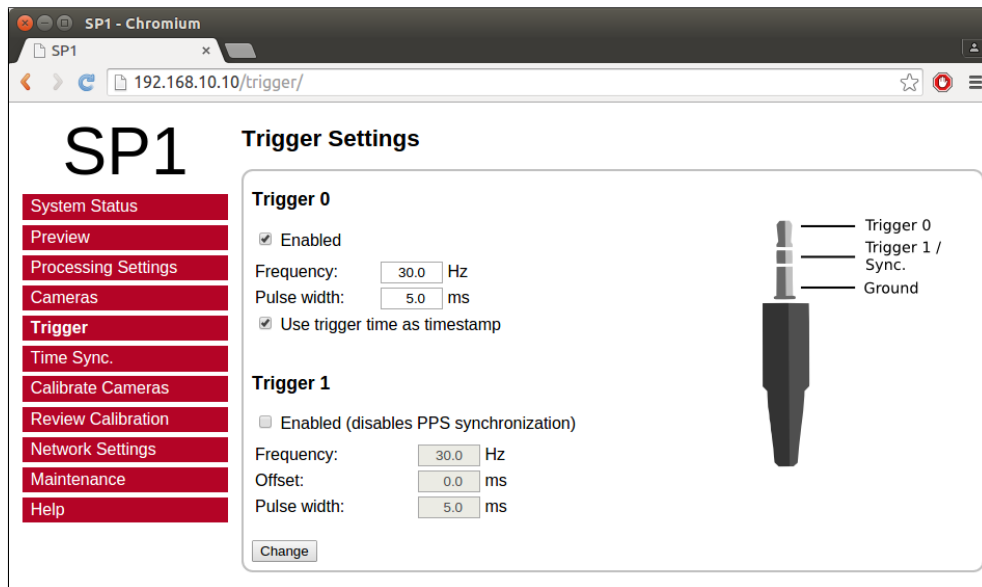

Figure 15: Screenshot of configuration page for trigger settings.

8.6 Time Synchronization

The *time synchronization* page, which is shown in Figure 16, can be used to configure two possible methods for synchronizing the SP1’s internal clock. As explained in Section 7.3, the internal clock is used for timestamping captured camera frames.

The first possible option is to synchronize with a time server, using the Network Time Protocol (NTP) up to version 4. In this case the SP1 synchronizes its internal clock to the given time server, using Coordinated Universal Time (UTC). The accuracy of the time synchronization depends on the latency of your network and time server. If NTP time synchronization is active, synchronization statistics are displayed in a dedicated status area.

When activating Pulse Per Second (PPS) synchronization, the internal clock is set to 0 whenever a synchronization signal is received, as explained in Section 6.6. Please note that PPS synchronization and the *trigger 1* output cannot be active at the same time, as they both use the same physical pin.

8.7 Camera Calibration

8.7.1 Calibration Board

The *calibrate cameras* page, which is shown in Figure 17, enables the calibration of the stereo camera pair. You require a calibration board, which is a flat panel with a visible calibration pattern on one side. The pattern that is used by the SP1 consists of an asymmetric grid of black circles on a white background, as shown in Figure 18.

The pattern can be downloaded directly from the calibration page. Simply

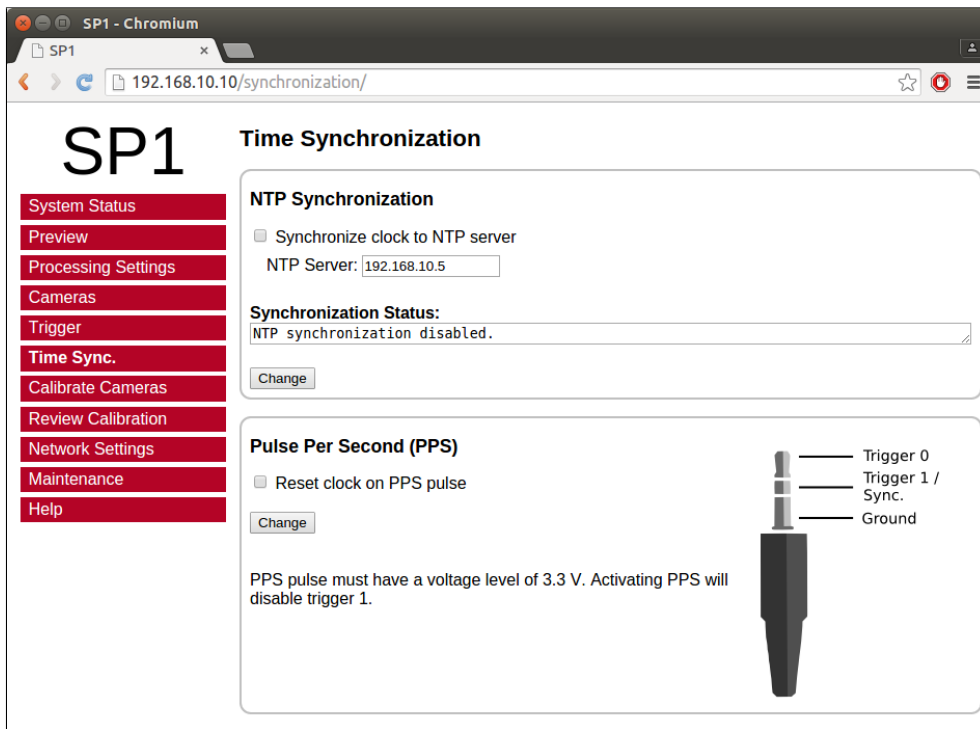

Figure 16: Screenshot of configuration page for time synchronization.

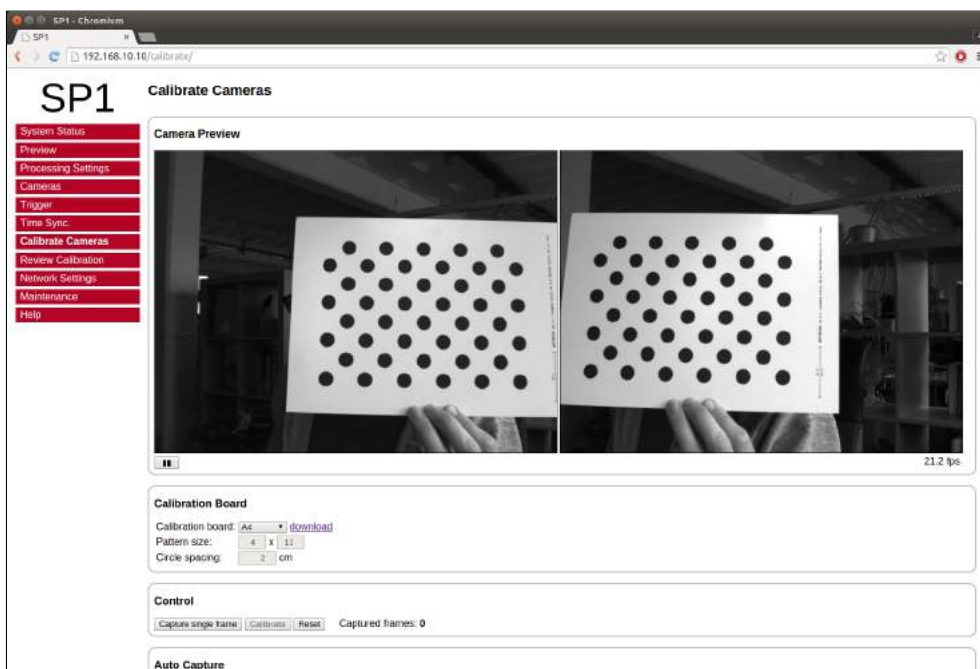

Figure 17: Screenshot of configuration page for camera calibration.

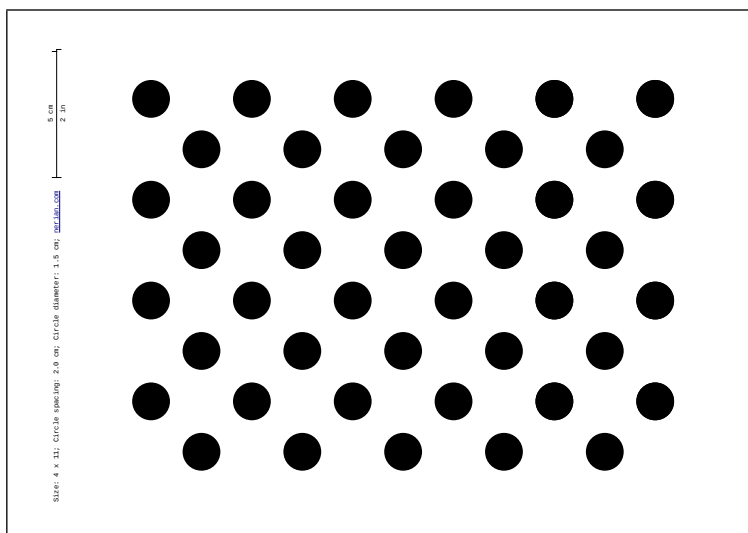

Figure 18: Calibration board used by SP1.

select the desired paper size in the *calibration board* drop-down list, and click the download link. Even if you already have a calibration board, make sure to always select the correct board size before starting the calibration process. Otherwise the calibration results cannot be used for 3D reconstruction with a correct metric scale (see Section 7.2).

Should you require a calibration board with a custom size, then you can select *custom* from the *calibration board* drop-down list. This allows you to enter the calibration board details manually. The first dimension of the *pattern size* is the number of circles in one grid column. This number must be equal for all columns of the circles grid.

The number of circles per row is allowed to vary by 1 between odd and even rows. The second dimension is thus the sum of circles in two consecutive rows. All downloadable default calibration patterns have a size of 4×11 .

The final parameter that you have to enter when using a custom calibration board is the *circle spacing*. This is the distance between the centers of two neighboring circles. The distance must be equal in horizontal and vertical direction for all circles.

8.7.2 Recording Calibration Frames

Once the calibration board settings have been set, you can begin recording calibration frames. A live preview of both cameras is displayed in the *camera preview* area. Make sure that the calibration board is fully visible in both camera images and then press the *capture single frame* button in the *control* section. Repeat this process several times while moving either the camera or the calibration board.

The calibration board must be recorded at several different positions and orientations. You should also vary the distance of the board to the cameras and

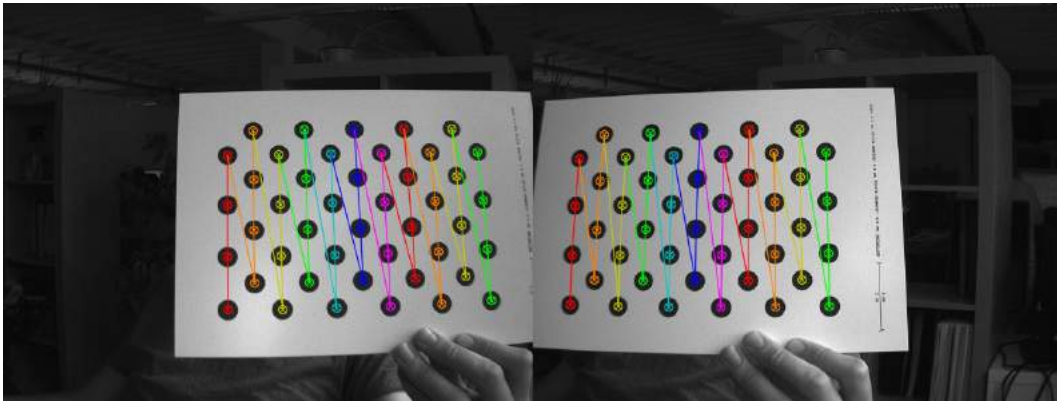

Figure 19: Example calibration frame with detected calibration board.

make sure that you cover most of the cameras' field of view. When recording the calibration frames it is important that both cameras are synchronized.

The more frames you record, the more accurate the computed calibration will be. However, more frames also cause the computation of the calibration parameters to take longer. The SP1 supports the recording of up to 40 calibration frames.

The recording of calibration frames can be simplified by activating the *auto capture* mode. In this mode, a new calibration frame is recorded in fix *capture intervals*. You can enter the desired interval in the auto capture section and then press the *start auto capture* button. If desired, an audible sound can be played to signal the countdown and the recording of a new frame. Auto capture mode can be stopped by pressing the *stop auto capture* button.

A small preview of each captured calibration frame is added to the *captured frames* section. The frames are overlaid with the detected positions of the calibration board circles. You can click any of the preview images to see the calibration frame at its full resolution. An example for a calibration frame with a correctly detected calibration board is shown in Figure 19. If the calibration board was not detected correctly or if you are unhappy with the quality of a calibration frame, then you can delete it by clicking on the \times -symbol.

8.7.3 Performing Calibration

Once you have recorded a sufficient number of calibration frames, you can initiate the calibration process by pressing the *calibrate* button in the *control* section. The time required for camera calibration depends on the number of calibration frames that you have recorded. Calibration will usually take several minutes to complete. If calibration is successful then you are immediately redirected to the *review calibration* page.

Calibration will fail if the computed vertical or horizontal pixel displacement exceeds the allowed range of $[-39, +39]$ pixels for any image point. The most common causes for calibration failures are:

- Insufficient number of calibration frames.
- Improperly aligned cameras. See Section 6.3.
- Lenses with strong geometric distortions.
- Lenses with unequal focal lengths.
- Improper camera synchronization.
- Frames with calibration board misdetections.

Should calibration fail, then please resolve the cause of error and repeat the calibration process. If the cause of error is one or more erroneous calibration frames, then you can delete those frame and re-press the *calibrate* button. Likewise, in case of too few calibration frames, you can record additional frames and restart the calibration process.

8.8 Reviewing Calibration Results

Once calibration has been performed, you can inspect the calibration results on the *review calibration* page, which is shown in Figure 20. On the top of this page you can see a live preview of both cameras, which have been rectified with the current calibration parameters. Please make sure that corresponding points in the images of both cameras have an identical vertical coordinate.

By activating the *display epipolar lines* option, you can overlay a set of horizontal lines on both camera images. This allows for an easy evaluation of whether the equal vertical coordinates criterion is met. An example for a left and right input image with overlaid epipolar lines is shown in Figure 21.

In the *quality information* section you can find the *average reprojection error*. This is a measure for the quality of your camera calibration, with lower values indicating better calibration results. Please make sure that the average reprojection error is well below 1 pixel.

All computed calibration parameters are displayed in the *calibration data* section. These parameters are:

M_1 and M_2 : camera matrices for the left and right camera.

D_1 and D_2 : distortion coefficients for the left and right camera.

R_1 and R_2 : rotation matrix for the rotation between the original and rectified camera images.

P_1 and P_2 : projection matrices in the new (rectified) coordinate systems.

Q : the disparity-to-depth mapping matrix. See Section 7.2 for its use.

T : translation vector between the coordinate systems of both cameras.

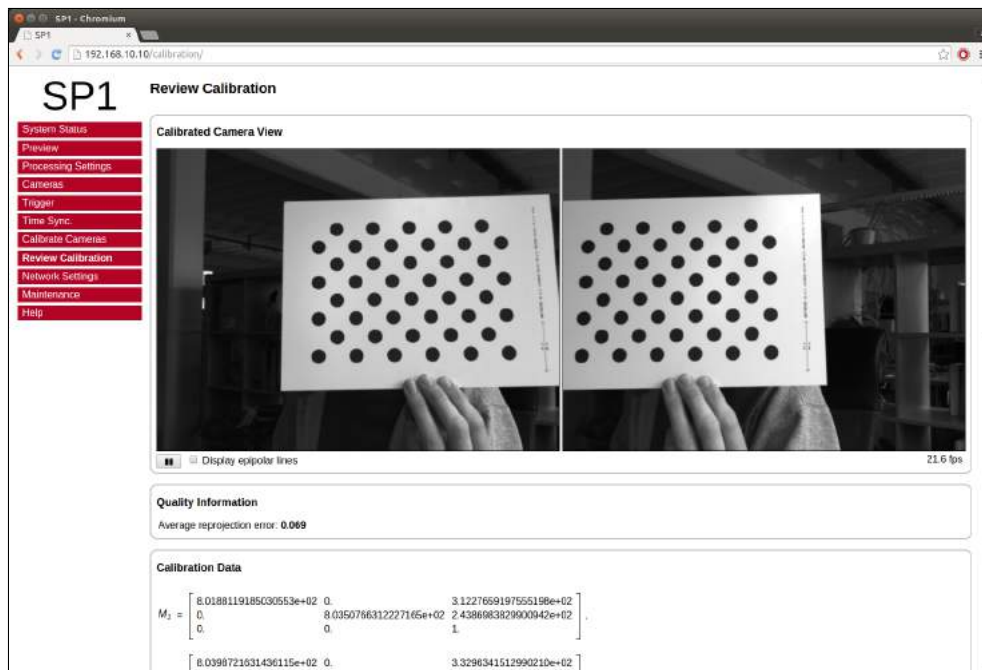

Figure 20: Screenshot of configuration page for reviewing camera calibration.



Figure 21: Example for evaluating vertical image coordinates.

R: rotation matrix between the coordinate systems of the left and right camera.

The camera matrices M_1 and M_2 are structured as follows:

$$M_i = \begin{bmatrix} f_x & 0 & c_x \\ 0 & f_y & c_y \\ 0 & 0 & 1 \end{bmatrix}, \quad (1)$$

where f_x and f_y are the lenses' focal lengths in horizontal and vertical direction (measured in pixels), and c_x and c_y are the image coordinates of the projection center.

The distortion coefficient vectors D_1 and D_2 have the following structure:

$$D_i = [k_1 \quad k_2 \quad p_1 \quad p_2 \quad k_3], \quad (2)$$

where k_1 , k_2 and k_3 are radial distortion coefficients, and p_1 and p_2 are tangential distortion coefficients.

You can download all calibration information as a machine-readable YAML file by clicking the download link at the bottom of the *calibration data* section. This allows you to easily import the calibration data into your own applications. Furthermore, you can save the calibration data to your PC and reload it at a later point, by using the *upload calibration data* section. This allows you to switch between different cameras or optics without repeating the calibration process.

You can also perform a reset of the calibration data by pressing the *reset calibration* button. In this case, image rectification is disabled, and the unmodified image data is passed on to the stereo matching algorithm. Use this option when selecting the already rectified virtual example camera, as explained in Section 6.4.

8.9 Auto Re-calibration

On the *auto re-calibration* page, which is shown in Figure 22, you can enable an automated estimation of the camera calibration parameters. In this case, the cameras remain calibrated even if their alignment is subject to variations. For this process to work, it is necessary that the cameras have been calibrated once before with the manual calibration procedure (see Section 8.7).

Calibration parameters are usually divided into *intrinsic* parameters (focal length, projection center and distortion coefficients) and *extrinsic* parameters (transformation between the poses of both cameras). Auto re-calibration only performs an update of the extrinsic parameters, as they are significantly more prone to variations. More specifically, only the rotation between the cameras is estimated. This is usually the most fragile parameter, which can be affected significantly by even minor deformations of the camera mount.

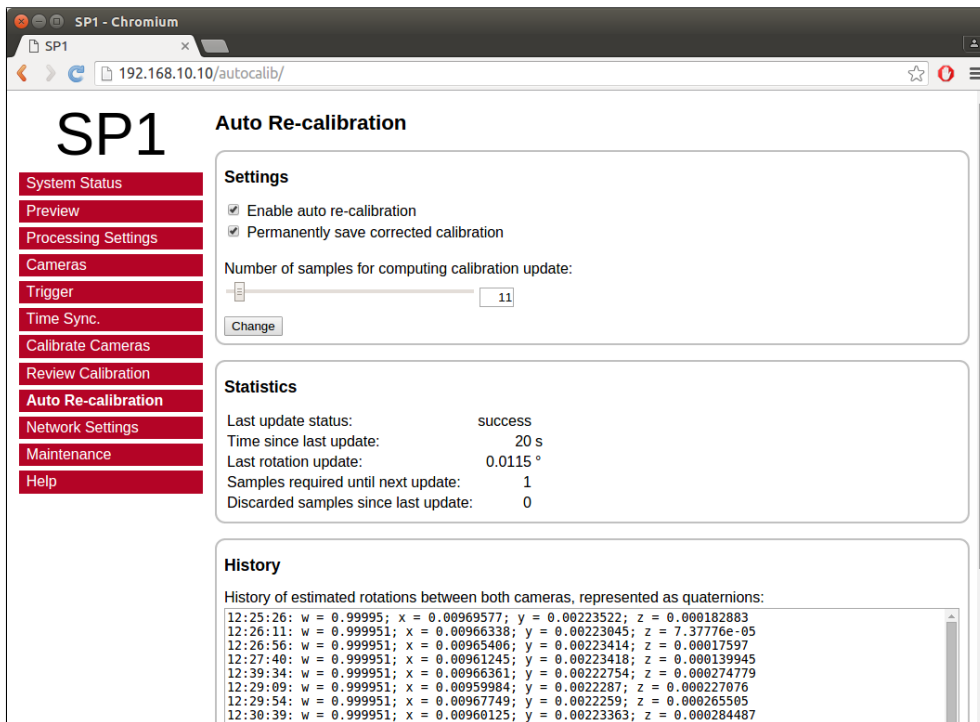

Figure 22: Screenshot of auto re-calibration settings.

Auto re-calibration can be activated by selecting the *enable auto re-calibration* option. The SP1 will then continuously compute samples for the estimated inter-camera rotation. A robust estimation method is applied for selecting a final rotation estimate from the set of rotation samples. The *number of samples* that are used for this estimation process can be configured. Small sample sizes allow for a quick reaction on alignment variations, while large sample sizes allow for very accurate estimates. If the *permanently save corrected calibration* option is selected, then the updated calibration is written to non-volatile memory and remains present even after a power cycle.

In the *statistics* area you can find various information on the current performance of the auto calibration process. This includes the status of the latest re-calibration attempt, the time since the last calibration update, the rotational offset of the last update and the number of rotation samples that have been collected and discarded since the last update. Finally, you can find a list of recently computed inter-camera rotations in the *history* area. The shown rotations are represented as rotation quaternions.

8.10 Network Settings

The *network settings* page, which is displayed in Figure 23, is used for configuring all network related parameters. In the *IP settings* section, you can specify an IP address, subnet mask and gateway address. When changing the IP settings, please make sure that your computer is in the same subnet, or that

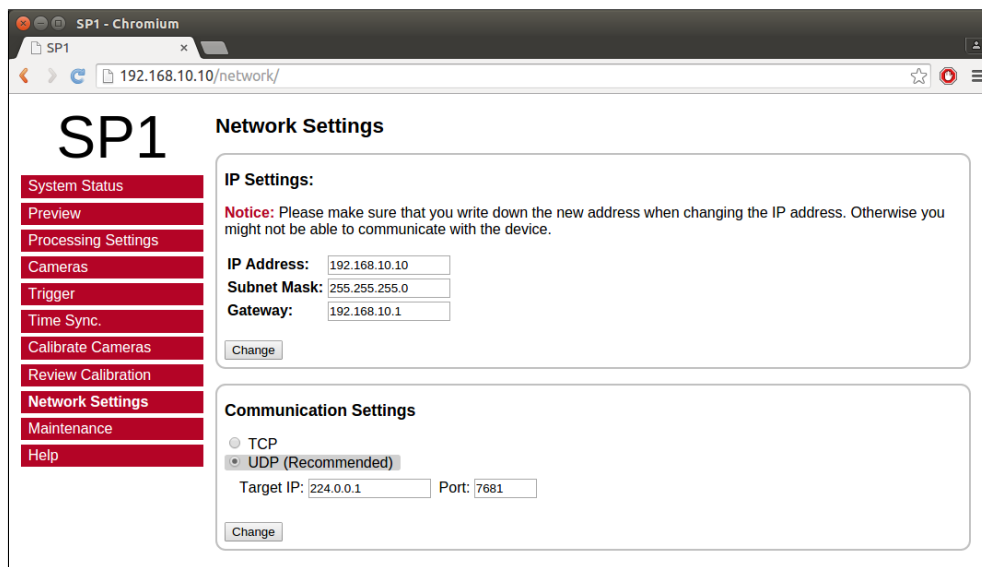

Figure 23: Screenshot of configuration page for network settings.

there exists a gateway router through which data can be transferred between both subnets. Otherwise you will not be able to access the SP1.

In the *communication settings* section, you can choose the underlying network protocol that shall be used for delivering the computation results to the client computer. The possible options are *TCP* and *UDP*. Due to the high-bandwidth real time data we recommend using *UDP*, unless the input images are transferred through ethernet, as described in Section 6.4.

If *TCP* is selected, the SP1 opens up the server port 7681 and waits for a client computer to connect before transmitting data. Because *UDP* is a connection-less protocol, data transmission starts instantly if *UDP* is selected. In *UDP* mode you thus have to specify the IP address and port number of the client computer. It is possible to enter a multicast address here, if you want the data to be received by multiple hosts or processes.

8.11 Maintenance

On the *maintenance* page that is shown in Figure 24 you can download a file that contains the current device configuration and the system logs, by pressing the *download* link. In case of technical problems please include this file in your support request, such that your device configuration can be reproduced and that system problems can be studied.

If you are experiencing troubles with your device configuration, you can reset all configuration settings to the factory defaults, by pressing the *reset* button. Please note that this will also reset the network configuration, which might lead to a change of the SP1's IP address.

The maintenance page further allows you to perform firmware updates. Use this functionality only for firmware files that have officially been released by

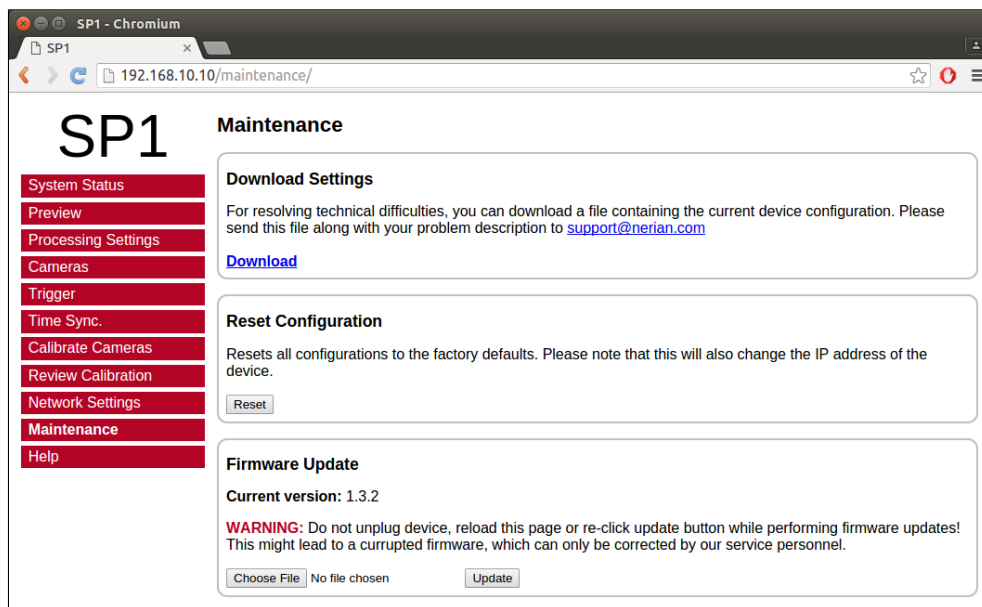

Figure 24: Screenshot of configuration maintenance page.

Nerian Vision Technologies. To perform a firmware update, select the desired firmware file and press the *update* button. The update process will take several seconds. Do not unplug the device, reload the maintenance page or re-click the update button while performing firmware updates. Otherwise, this might lead to a corrupted firmware state. Once the update has been completed, please restart the device by briefly unplugging the power supply.

9 API Usage Information

9.1 General Information

The cross-platform *libvisiontransfer* C++ API is available for interfacing custom software with the SP1. For windows, a binary version of the library is available that can be used with Microsoft Visual Studio 2013 and 2015. For Linux and Mac OSX, please compile the library from the available source code package. The API can be downloaded from our support website².

The *libvisiontransfer* API provides functionality for receiving the processing results of the SP1 over a computer network. Furthermore, the API also allows for the transmission of image pairs. It can thus be used for emulating the SP1 when performing systems development, or for transmitting image data to the SP1 when using network image input.

The transmitted processing results always consist of two images. Usually these are the rectified left camera image and the computed left camera disparity

²<http://nerian.com/support/software/>

map. If configured, however, the SP1 can also provide the raw camera images or the rectified images of both cameras (see Section 8.4).

Original and rectified camera images are always transmitted with a bit-depth of 8 bits per pixel. The disparity map is always transmitted with a bit depth of 12 bits. Inside the library, the disparity map is inflated to 16 bits to allow for more efficient processing.

The API provides three classes that can be used for receiving and transmitting image pairs:

- `ImageProtocol` is the most low-level interface. This class allows for the encoding and decoding of image pairs to / from network messages. You will have to handle all network communication yourself.
- `ImageTransfer` opens up a network socket for sending and receiving image pairs. This class is single-threaded and will thus block when receiving or transmitting data.
- `AsyncTransfer` allows for the asynchronous reception or transmission of image pairs. This class creates one or more threads that handle all network communication.

Detailed information on the usage of each class can be found in the available API documentation.

9.2 ImageTransfer Example

An example for using the class `ImageTransfer` to receive processing results over the network, and writing them to image files, is shown below. This source code file is part of the API source code package. Please refer to the API documentation for further information on using `ImageTransfer`.

```
#include <visiontransfer/imagetransfer.h>
#include <visiontransfer/imagepair.h>
#include <iostream>
#include <exception>
#include <stdio.h>

#ifdef _MSC_VER
// Visual studio does not come with snprintf
#define snprintf _snprintf_s
#endif

int main() {
    try {
        // Create an image transfer object that receives data from
        // the SP1 on the default port using UDP
        ImageTransfer imageTransfer(ImageTransfer::UDP, NULL, NULL,
            NULL, "7681");
```

```

// Receive 100 images
for(int i=0; i<100; i++) {
    std::cout << "Receiving_image_" << i << std::endl;

    // Receive image
    ImagePair imagePair;
    while(!imageTransfer.receiveImagePair(imagePair, true)) {
        // Keep on trying until reception is successful
    }

    // Write both images one after another
    for(int imageNumber = 0; imageNumber <=1; imageNumber++) {
        // Create PGM file
        char fileName[100];
        snprintf(fileName, sizeof(fileName), "image%03d_%d.pgm", i,
            imageNumber);

        imagePair.writePgmFile(imageNumber, fileName);
    }
}
} catch(const std::exception& ex) {
    std::cerr << "Exception_occurred:" << ex.what() << std::endl;
}

return 0;
}

```

9.3 AsyncTransfer Example

An example for using the class `AsyncTransfer` to receive processing results over the network, and writing them to image files, is shown below. This source code file is part of the API source code package. Please refer to the API documentation for further information on using `AsyncTransfer`.

```

#include <visiontransfer/asynctransfer.h>
#include <visiontransfer/imagepair.h>
#include <iostream>
#include <exception>
#include <stdio.h>

#ifdef _MSC_VER
// Visual studio does not come with snprintf
#define snprintf _snprintf_s
#endif

int main() {
    try {
        // Create an async transfer object that receives data from
        // the SP1 on the default port using UDP
        AsyncTransfer asyncTransfer(ImageTransfer::UDP, NULL, NULL,

```

```

    NULL, "7681");

// Receive 100 images
for(int i=0; i<100; i++) {
    std::cout << "Receiving image" << i << std::endl;

    // Alternatingly receive the first and second image
    ImagePair imagePair;
    while(!asyncTransfer.collectReceivedImagePair(imagePair,
        0.1 /*timeout*/)) {
        // Keep on trying until reception is successful
    }

    // Write both images one after another
    for(int imageNumber = 0; imageNumber <=1; imageNumber++) {
        // Create PGM file
        char fileName[100];
        snprintf(fileName, sizeof(fileName), "image%03d_%d.pgm", i,
            imageNumber);

        imagePair.writePgmFile(imageNumber, fileName);
    }
}
} catch(const std::exception& ex) {
    std::cerr << "Exception occurred:" << ex.what() << std::endl;
}

return 0;
}

```

9.4 3D Reconstruction

As described in Section 7.2, the disparity map can be transformed into a set of 3D points. This requires knowledge of the disparity-to-depth mapping matrix Q (see Section 7.2), which is transmitted by the SP1 along with each disparity map.

An optimized implementation of the required transformation, which uses SSE or AVX instructions, is provided by the API through the class `Reconstruct3D`. This class converts a disparity map to a map of 3D point coordinates. Please see the API documentation for details on using this class.

10 Supplied Software

10.1 SpCom Sample Application

The downloadable source code or binary version of the libvisiontransfer API also include the SpCom sample application, which is shown in Figure 25. When compiling this application yourself, please make sure that you have the libraries OpenCV and libSDL installed.



Figure 25: Screenshot of SpCom sample application.

Table 1: Available command line options for SpCom.

-c	Color code the disparity map.
-s <i>directory</i>	Send images from the given directory. If not specified, only image reception is active.
-n	Non-graphical mode. No display window will be opened.
-d	Disable image reception. Use this option if you want to transmit images only.
-f <i>number</i>	Limits the frame rate to the given value. This option can be used for controlling the frame rate when transmitting images.
-w <i>directory</i>	Immediately start writing all received images to the given directory.
-h <i>hostname</i>	Use the given remote hostname for communication. Only required for TCP communication and for transmitting images through UDP. By default this parameter is set to 192.168.10.10.
-p <i>port</i>	Use the given remote port number for communication. Only required for TCP communication and for transmitting images through UDP. By default this parameter is set to 7681.
-H <i>hostname</i>	Use the given local hostname as local interface address. If not specified, the default interface will be used.
-P <i>port</i>	Use the given local port number for communication. Only necessary for receiving images through UDP. By default this parameter is set to 7681.
-t	Use TCP instead of UDP as the underlying network protocol.
-r	Output the disparity map (right image) as 16-bit image without bit-depth conversion.
-i <i>0/1</i>	Only display image 0 (left) or 1 (right).

SpCom provides the following features:

- Receive and display images and disparity maps from SP1.
- Perform color-coding of disparity maps.
- Write received data to image files.
- Transmit image pairs to SP1.
- Simulate SP1 by transmitting images and disparity maps.

SpCom should be run from a terminal in order to supply command line arguments and to view the printed status messages. If the graphical mode is not disabled, then SpCom opens up a window for displaying the received images. The currently displayed images can be written to files by pressing the *space* key. When pressing the *enter* key, all received images are written to files up until *enter* is re-pressed. The created image files are located in the current working directory.

SpCom can be controlled through the command line options listed in Table 1. Most commonly, SpCom is used to display the color coded disparity map that is transmitted by SP1. If using UDP as underlying network protocol and the default port number 7681, this can be achieved by executing SpCom with the following command line:

```
> spcom -c
```

10.2 GenICam GenTL Producer

10.2.1 Installation

The available software package further includes a software module that complies to the GenICam GenTL standard. The GenTL standard specifies a generic transport layer interface for accessing cameras and other imaging devices. According to the GenICam naming convention, a GenTL producer is a software driver that provides access to an imaging device through the GenTL interface. A GenTL consumer, on the other hand, is any software that uses one or more GenTL producers through this interface. The supplied software module represents a GenTL producer and can be used with any application software that acts as a consumer. This allows for the ready integration of the SP1 into existing machine vision software suites like e.g. HALCON.

Depending on the package that you download, the producer is provided either as a binary or as source code. If you choose the source code package, the producer will be built along with the other software components. The produced / downloaded binary is named `nerian-gentl.cti`. In order to be found by a consumer, this file has to be placed in a directory that is in the

GenTL search path. The search path is specified through the following two environment variables:

`GENICAM_GENTL32_PATH`: Search path for 32-bit GenTL producers.

`GENICAM_GENTL64_PATH`: Search path for 64-bit GenTL producers.

The binary windows version includes the batch script `register_gentl.bat` for setting these environment variables automatically. After this scripts has been execute, the environment variables remain set even after a system reboot. Please note that the script has to be rerun if the producer is moved to a different location. On Linux and Mac OS X systems please set the appropriate environment variable manually.

10.2.2 Virtual Devices

Once the search path has been set, the producer is ready to be used by a consumer. For each SP1 the producer provides three *virtual devices*, which each deliver one part of the obtained data. These virtual devices are named as follows:

- 0:** The first image that is transmitted by the SP1. In the default configuration this is the rectified image of the left camera with a pixel format of 8 bits per pixel (Mono8).
- 1:** The second image that is transmitted by the SP1. In the default configuration this is the sub-pixel accurate disparity map (see Section 7.2), which is transmitted non-packed with 12 bits per pixel (Mono12).
- pointcloud:** A transformation of the disparity map into a 3D point cloud (see Section 7.2). Each pixel in this ‘image’ is represented by three 32-bit floating point numbers that encode an x-, y- and z-coordinate (Coord3D_ABC32f).

The virtual devices *0* and *1* deliver the unprocessed data that is received by the SP1. The data obtained through the *pointcloud* device is computed by the producer from the received disparity map. This is done by multiplying the disparity map with the disparity-to-depth mapping matrix *q* (see Section 7.2), which is transmitted by the SP1 along with each image pair. Invalid disparities are set to the minimum disparity and thus result in points with very large distances.

10.2.3 Device IDs

All device IDs that are assigned by the producer are URLs and consist of the following components:

```
[protocol]://[address]:[port]/[virtual device]
```

The *protocol* component identifies the underlying transport protocol that shall be used for communication. The following values are possible:

udp: Use the connection-less UDP transport protocol for communication. In this case the *address* identifies the network interface that shall be selected. If the address is set to 0.0.0.0, the default interface used.

tcp: Use the connection oriented TCP transport protocol for communication. In this case the *address* has to be set to the network address of the SP1.

The *port* is usually set to 7681, which is the default port number that is used by the SP1 for UDP and TCP communication. The *virtual device* shall be set to one of the device names that have been listed in the previous section. Some examples for valid device IDs are:

```
udp://0.0.0.0:7681/pointcloud
tcp://192.168.10.100:7681/0
```

10.2.4 Device Enumeration

By manually specifying the correct device ID it is possible to connect to any SP1 that is reachable through a network interface. Unfortunately, many GenTL consumers do not allow the user to manually enter a device ID. The producer thus forwards a list of presumably connected devices to the consumer. By default, this list consists of the virtual devices that correspond to a UDP communication on the default port. The corresponding device IDs are:

```
udp://0.0.0.0:7681/0
udp://0.0.0.0:7681/1
udp://0.0.0.0:7681/pointcloud
```

In order to connect to other devices without entering a device ID directly, the producer has to be configured such that it provides a different list of connected devices to the consumer. This can be done by setting the environment variable `NERIAN_GENTL_DEVICES`. This variable contains a semicolon separated list of device IDs that will be reported as connected. If this environment variable is defined, the default list of connected devices is overwritten.

10.3 ROS Node

For integrating the SP1 with the Robot Operating System (ROS), there exists an official ROS node. This node is called `nerian_sp1` and can be found in the official ROS package repository. The node publishes the computed disparity map and the corresponding 3D point cloud as ROS topics. Furthermore, it can publish camera calibration information.

To install this node from the ROS package servers on a Ubuntu Linux system, please use the following commands:

```
> sudo apt-get update
> sudo apt-get install ros-`rosversion`-d-nerian-sp1
```

Detailed information on this node can be found on the corresponding ROS wiki page³.

11 Support

If you require support or if you have other inquiries that are related to this product, please contact:

Nerian Vision Technologies
Dr. Konstantin Schauwecker
Gotenstr. 9
70771 Leinfelden-Echterdingen
Germany
Phone: +49 711 2195 9414
E-mail: service@nerian.com

Website: <http://nerian.com>

12 Warranty Information

The device is provided with a 2 year warranty according to German federal law (BGB). Warranty is lost if:

- the housing is opened by others than official Nerian Vision Technologies service staff.
- the firmware is modified or replaced, except for official firmware updates.

In case of warranty please contact our support staff.

13 Open Source Information

The SP1 firmware contains code from the open source libraries and applications listed in Table 2. Source code for these software components and the wording of the respective software licenses can be obtained from the open source information website⁴. Some of these components may contain code from other open source projects, which may not be listed here. For a definitive list, please consult the respective source packages.

³http://wiki.ros.org/nerian_sp1

⁴<http://nerian.com/support/resources/sp1-open-source/>

Table 2: Open source components.

Name	Version	License(s)
busybox	1.22.1	GNU GPL 2.0
dropbear	2014.63	MIT License BSD License OpenSSH License
glib	2.40	GNU LGPL 2.0
libdc1394	2.2.3 (patched)	GNU LGPL 2.1
libffi	3.1	MIT License
libusb	1.0.18	GNU LGPL 2.1
libwebsockets	1.3	GNU LGPL 2.1
libxml2	2.9.1	MIT License
linux	3.18.0-xilinx	GNU GPL 2.0
ntp	4.2.8	BSD License MIT License
opencv	2.4.9	BSD License libpng License JasPer License 2.0
openssl	1.0.2c	OpenSSL License
PHP	5.5.16	PHP License
Sourcery CodeBench Lite for Xilinx Cortex-A9 GNU/Linux	2014.11-30	GNU GPL 2.0 GNU GPL 3.0 Mentor Graphics License BSD / Various
u-boot	xilinx-v2015.2	GNU GPL 2.0
zlib	1.2.8	Zlib License

The following individuals have requested to be named as author or co-author of one of the included open source projects:

The PHP Group, Google Inc., The Android Open Source Project, Red Hat Incorporated, University of California, Berkeley, David M. Gay, Christopher G. Demetriou, Royal Institute of Technology, Alexey Zelkin, Andrey A. Chernov, FreeBSD, S.L. Moshier, Citrus Project, Todd C. Miller, DJ Delorie, Intel Corporation, Henry Spencer, Mike Barcroft, Konstantin Chuguev, Artem Bityuckiy, IBM, Sony, Toshiba, Alex Tatmanjants, M. Warner Losh, Andrey A. Chernov, Daniel Eischen, Jon Beniston, ARM Ltd, CodeSourcery Inc, MIPS Technologies Inc, Addison-Wesley, Advanced Micro Devices Inc., Alexander Chemeris, Alexander Neundorf, Alexandre Benoit, Alexandre Julliard, Andreas Dilger, Andrei Alexandrescu, Andrey Kamaev, Annecy le Vieux and GIPSA Lab, Argus Corp, Arren Glover, AWARE Systems, Baptiste Coudurier, Chih-Chung Chang, Chih-Jen Lin, Christopher Diggins, Clement Boesch, David G. Lowe, Edward Rosten, Enrico Scholz, EPFL Signal processing laboratory 2, Ethan Rublee, ETH Zurich Autonomous Systems Lab (ASL), Fabrice Bellard, Farhad Dadgostar, Frank D. Cringle, Glenn Randers-Pehrson, Google Inc., Greg Ward Larson, Group 42 Inc., Guy Eric Schalnat, Image Power Inc., Industrial Light & Magic, Institute Of Software Chinese Academy Of Science, Intel Corporation, Ivan Kalvachev, James Almer, Javier Sánchez Pérez, Jean-loup Gailly, Joris Van Damme Joseph O'Rourke, Jostein Austvik Jacobsen, Justin Ruggles, Ken Turkowski, Kevlin Henney, GIPSA French Labs, LISTIC Lab, Liu Liu, Maarten Lankhorst, Makoto Matsumoto, Mans Rullgard, Marius Muja, Mark Adler, Martin Storsjo, Michael David Adams, Michael Niedermayer, Microsoft Corporation, Multicoreware Inc., Nicolas George, Nils Hasler, NVIDIA Corporation, OpenCV Foundation, Pablo Aguilar, Peter Ross, PhaseSpace Inc., Philipp Wagner, Pixar Animation Studios, Reimar Döffinger, Rob Hess, Ryan Martell, Sam Leffler, Samuel Pitoiset, Silicon Graphics Inc., Simon Perreault, Smartjog S.A.S, Splitted-Desktop Systems, Takuji Nishimura, The Khronos Group Inc., The Regents of the University of California, the Sphinx team, The University of British Columbia, the Wine project, Thomas G. Lane, University of Augsburg, Weta Digital Ltd, William Lucas, Willow Garage Inc., Xavier Delacour, Yossi Rubner, University of Delaware, Martin Burnicki, Harlan Stenn, Danny Mayer

If you believe that your name should be included in this list, then please let us know.

Revision History

Revision	Date	Author(s)	Description
v1.8	May 26, 2016	KS	Added texture filter, updated example setup, description of mounting plate installation.
v1.7	Mar. 1, 2016	KS	Description of new auto re-calibration feature. Updated list of compatible cameras.
v1.6	Feb. 12, 2016	KS	Removed disclaimer for network image transfer in Sec. 6.4, added coordinate system to Sec. 7.2 and added configuration reset to Sec. 8.11.
v1.5	Jan. 11, 2016	KS	Dynamic image sizes and further extensions for firmware 1.3.0.
v1.4	Dec. 14, 2015	KS	Output of trigger time as timestamp.
v1.3	Dec. 8, 2015	KS	Added GenTL Producer and ROS node description.
v1.2	Nov. 23, 2015	KS	Updated for firmware 1.1.0 and libvisiontransfer 2.0.0: time synchronization, network image input, timestamps, sequence numbers, various smaller changes.
v1.1	Sept. 21, 2015	KS	Speckle filter, corrections to open source information.
v1.0	Aug. 28, 2015	KS	List of compatible cameras, information on IDS cameras, software download link, extended open source information, general improvements.
v0.1	July 30, 2015	KS	Initial revision